

***MasterPower***<sup>®</sup>

# **USER MANUAL**

**1.5KW/3KW/5KW  
SOLAR INVERTER / CHARGER**

# Table Of Contents

<b>ABOUT THIS MANUAL</b> .....	<b>1</b>
Purpose .....	1
Scope .....	1
<b>SAFETY INSTRUCTIONS</b> .....	<b>1</b>
<b>INTRODUCTION</b> .....	<b>2</b>
Features .....	2
Basic System Architecture .....	2
Product Overview.....	3
<b>INSTALLATION</b> .....	<b>4</b>
Unpacking and Inspection.....	4
Preparation .....	4
Mounting the Unit.....	4
Battery Connection .....	5
AC Input/Output Connection .....	7
PV Connection .....	8
Final Assembly .....	9
Remote Display Panel Installation .....	10
Communication Options.....	11
Dry Contact Signal .....	12
BMS Communication .....	12
<b>OPERATION</b> .....	<b>13</b>
Power ON/OFF .....	13
Operation and Display Panel .....	13
LCD Display Icons .....	14
LCD Setting.....	16
Display Setting .....	30
Operating Mode Description .....	35
Battery Equalization Description.....	37
Fault Reference Code .....	39
Warning Indicator .....	39
<b>SPECIFICATIONS</b> .....	<b>40</b>
Table 1 Line Mode Specifications .....	40
Table 2 Inverter Mode Specifications .....	41
Table 3 Charge Mode Specifications .....	42
Table 4 General Specifications .....	42
<b>TROUBLE SHOOTING</b> .....	<b>43</b>
<b>Appendix A: Approximate Back-up Time Table</b> .....	<b>44</b>
<b>Appendix B: BMS Communication Installation</b> .....	<b>45</b>

# ABOUT THIS MANUAL

## Purpose

This manual describes the assembly, installation, operation and troubleshooting of this unit. Please read this manual carefully before installations and operations. Keep this manual for future reference.

## Scope

This manual provides safety and installation guidelines as well as information on tools and wiring.

# SAFETY INSTRUCTIONS



**WARNING: All safety instructions in this document must be read, understood and followed. Failure to follow these instructions will result in death or serious injury.**

1. Before using the unit, read all instructions and cautionary markings on the unit, the batteries and all appropriate sections of this manual.
2. **CAUTION** --To reduce risk of injury, charge only deep-cycle lead acid type rechargeable batteries. Other types of batteries may burst, causing personal injury and damage.
3. Do not disassemble the unit. Take it to a qualified service center when service or repair is required. Incorrect re-assembly may result in a risk of electric shock or fire.
4. To reduce risk of electric shock, disconnect all wirings before attempting any maintenance or cleaning. Turning off the unit will not reduce this risk.
5. **CAUTION** – Only qualified personnel can install this device with battery.
6. **NEVER** charge a frozen battery.
7. For optimum operation of this inverter/charger, please follow required spec to select appropriate cable size. It's very important to correctly operate this inverter/charger.
8. Be very cautious when working with metal tools on or around batteries. A potential risk exists to drop a tool to spark or short circuit batteries or other electrical parts and could cause an explosion.
9. Please strictly follow installation procedure when you want to disconnect AC or DC terminals. Please refer to INSTALLATION section of this manual for the details.
10. One piece of 150A fuse is provided as over-current protection for the battery supply.
11. GROUNDING INSTRUCTIONS -This inverter/charger should be connected to a permanent grounded wiring system. Be sure to comply with local requirements and regulation to install this inverter.
12. NEVER cause AC output and DC input short circuited. Do NOT connect to the mains when DC input short circuits.
13. **Warning!!** Only qualified service persons are able to service this device. If errors still persist after following troubleshooting table, please send this inverter/charger back to local dealer or service center for maintenance.
14. **WARNING:** Because this inverter is non-isolated, only three types of PV modules are acceptable: single crystalline, poly crystalline with class A-rated and CIGS modules. To avoid any malfunction, do not connect any PV modules with possible current leakage to the inverter. For example, grounded PV modules will cause current leakage to the inverter. When using CIGS modules, please be sure NO grounding.
15. **CAUTION:** It's requested to use PV junction box with surge protection. Otherwise, it will cause damage on inverter when lightning occurs on PV modules.

## INTRODUCTION

This is a multi-function inverter, combining functions of inverter, solar charger and battery charger to offer uninterruptible power support in a single package. The comprehensive LCD display offers user-configurable and easy-accessible button operations such as battery charging current, AC or solar charging priority, and acceptable input voltage based on different applications.

## Features

- Pure sine wave inverter
- Configurable input voltage ranges for home appliances and personal computers via LCD control panel
- Configurable battery charging current based on applications via LCD control panel
- Configurable AC/Solar Charger priority via LCD control panel
- Compatible to utility mains or generator power
- Auto restart while AC is recovering
- Overload / Over temperature / short circuit protection
- Smart battery charger design for optimized battery performance
- Cold start function
- Removable LCD control module
- Multiple communication ports for BMS (RS485, CAN-BUS, RS232)
- Built-in Bluetooth for mobile monitoring (Requires App), OTG USB function, dusk filters
- Configurable AC/PV Output usage timer and prioritization

## Basic System Architecture

The following illustration shows basic application for this unit. It also required the following devices to have a complete running system:

- Generator or Utility mains.
- PV modules

Consult with your system integrator for other possible system architectures depending on your requirements.

This inverter can power various appliances in home or office environment, including motor-type appliances such as tube light, fan, refrigerator and air conditioners.

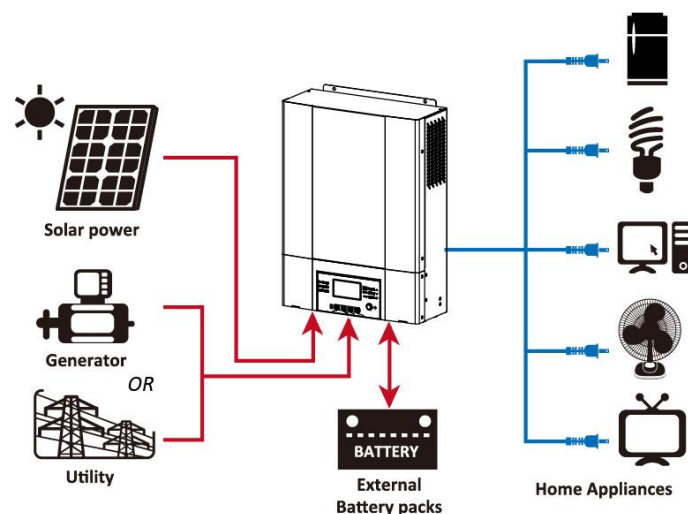
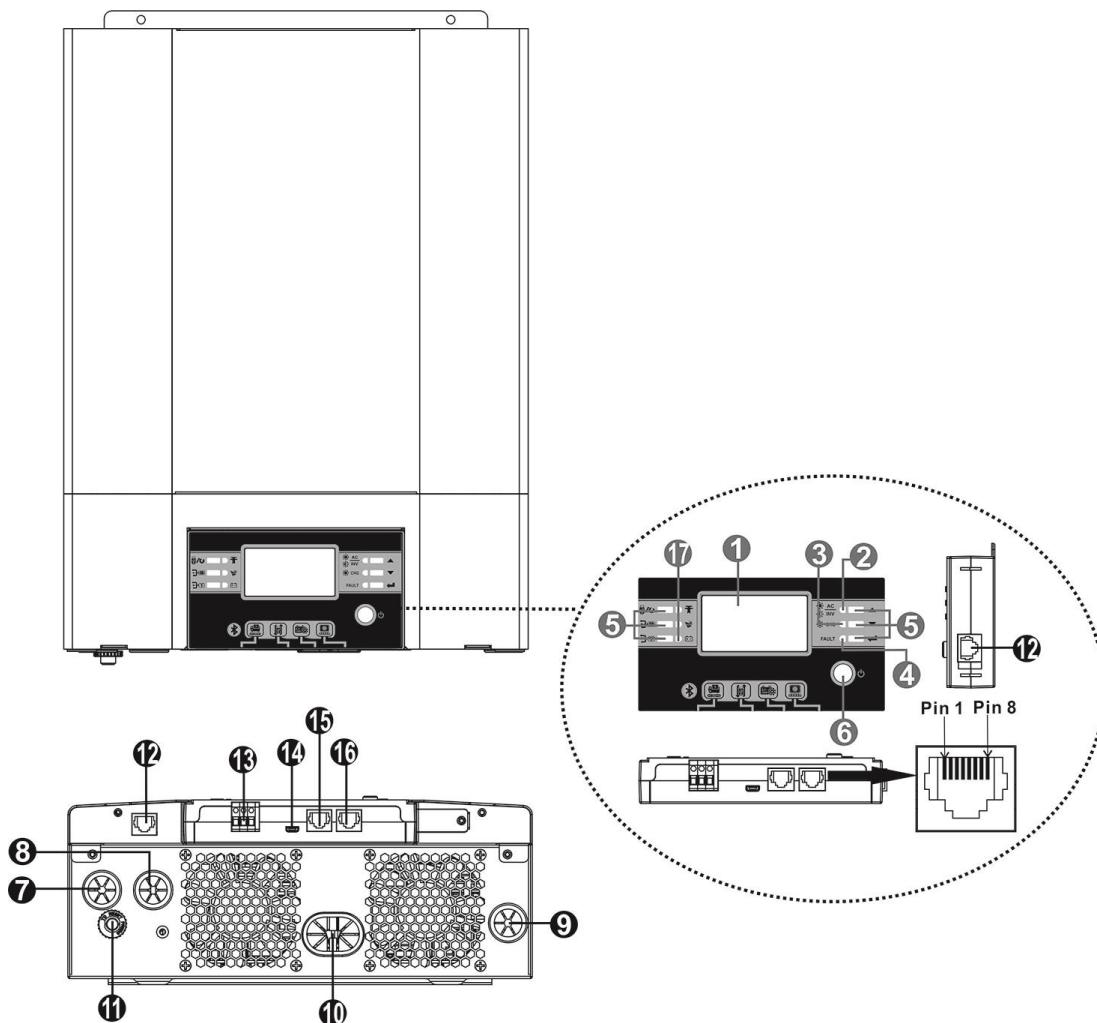

Figure 1 Hybrid Power System

# Product Overview



1. LCD display
2. Status indicator
3. Charging indicator
4. Fault indicator
5. Function buttons
6. Power on/off switch
7. AC input
8. AC output
9. PV input
10. Battery input
11. Circuit breaker
12. Remote LCD panel communication port
13. Dry contact
14. USB communication port
15. BMS communication port: CAN and RS232 or RS485
16. RS-232 communication port
17. Output source indicators (refer to OPERATION/Operation and Display Panel section for details) and USB function setting reminder (refer to OPERATION/Function Setting for the details)

# INSTALLATION

## Unpacking and Inspection

Before installation, please inspect the content. Be sure that nothing inside the package is damaged. You should have received the following items inside the package:

- Inverter x 1
- User manual x 1
- RS232 Communication cable x 1
- Software CD x 1
- DC Fuse x 1

## Preparation

Before connecting all wirings, please take off the bottom cover by removing two screws as shown below. Detach the cables from the cover.

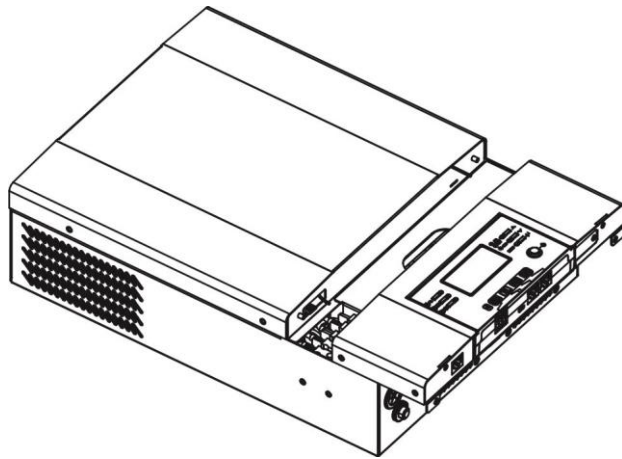

## Mounting the Unit

Consider the followings before selecting your placements:

- Do not mount the inverter on flammable construction materials.
- Mount on a solid surface
- Install the inverter at eye level in order to allow easy LCD display readout.
- For proper air circulation and heat dissipation, allow a clearance of approx. 20 cm to the side and approx. 50 cm above and below the unit.
- The ambient temperature should be between 0°C and 55°C to ensure optimal operation.
- The recommended orientation is to adhere to the wall vertically.

Be sure to keep other objects and surfaces as shown in the diagram to guarantee sufficient heat dissipation and to have enough space for wirings.

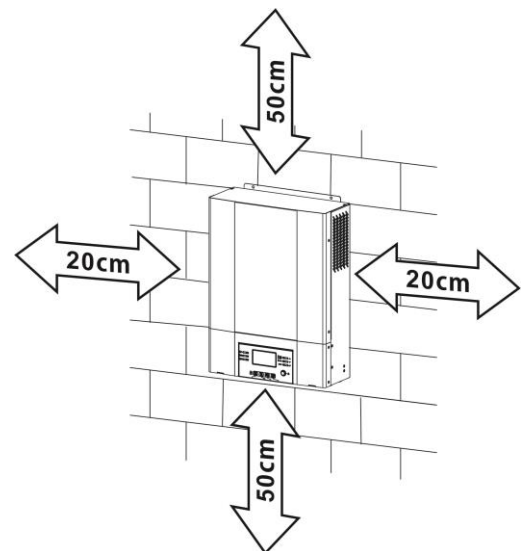

**SUITABLE FOR MOUNTING ON CONCRETE OR OTHER NON-COMBUSTIBLE SURFACE ONLY.**

Mounting the unit by screwing the three screws as shown below. It's recommended to use M4 or M5 screws.

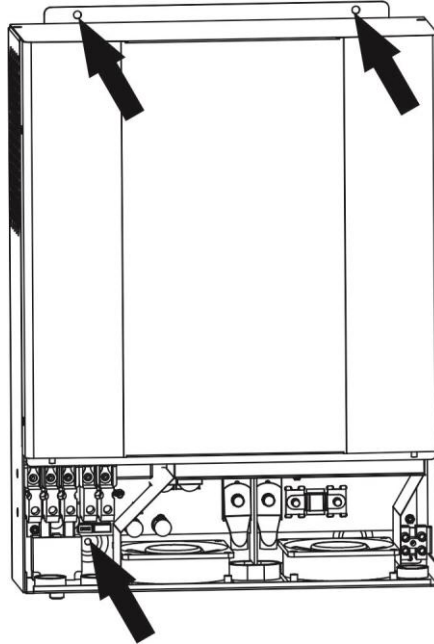

## Battery Connection

**CAUTION:** For safety operation and regulation compliance, it's requested to install a separate DC over-current protector or disconnection device between battery and the inverter. It may not be necessary to have a disconnection device in some applications, however, it's still recommended to have over-current protection installed. Please refer to typical amperage as required.

**WARNING!** All wiring must be performed by a qualified electrical technician.

**WARNING!** It's very important for system safety and efficient operation to use appropriate cables for battery connection. To reduce risk of injury, please use the proper recommended cable in the table below.

**Ring terminal:**

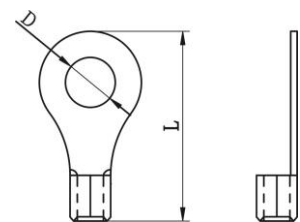

**Recommended battery cable size:**

Model	Typical Amperage	Wire Size	Cable mm <sup>2</sup>	Ring Terminal Dimensions		Torque Value
				D (mm)	L (mm)	
				1.5KW	71A	
3KW	142A	1*2AWG	38	8.4	39.2	5 Nm
5KW	118A	1*2AWG	38	8.4	39.2	

Please take the following steps to implement battery connection:

1. Assemble battery ring terminal based on recommended battery cable and terminal size. This step only applied to 3KW/5KW models.
2. Connect all battery packs as required. It is recommend to connect minimum of 100Ah capacity battery for 1.5KW/3KW model and 200Ah capacity battery for 5KW model.

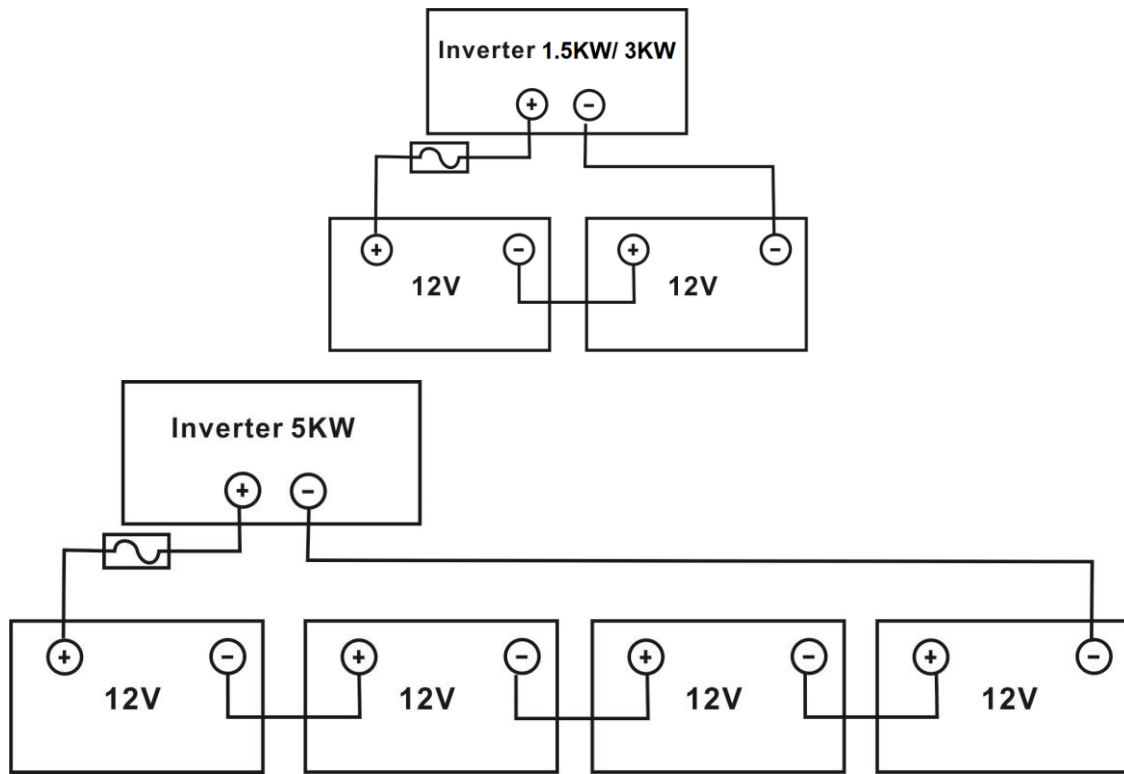

3. For the 1.5KW model, remove the insulation sleeve for about 18mm for positive and negative wires. Connect the two wires to the proper screw terminal on the unit. For 3KW/5KW models, apply ring terminals to your battery wires and secure it to the battery terminal block with the bolts properly tightened. Refer to battery cable size for torque value. Make sure polarity at both the battery and the inverter is correctly connected and ring terminals are secured to the battery terminals.

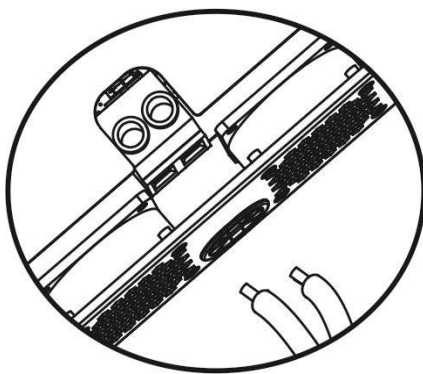

**1.5KW Model**

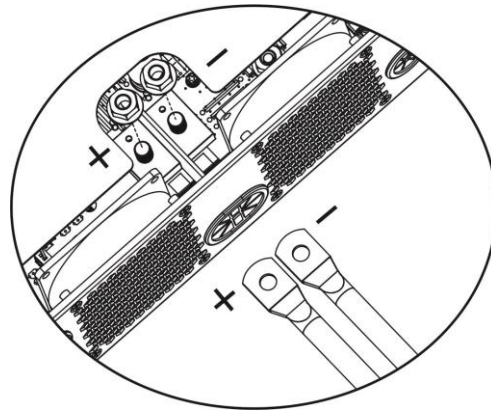

**3KW/5KW Model**

 **WARNING: Shock Hazard**  
Installation must be performed with care due to high battery voltage in series.

 **CAUTION!!** Do not place anything between inverter terminals and the ring terminals. Otherwise, overheating may occur.  
**CAUTION!!** Do not apply anti-oxidant substance on the terminals before terminals are securely tightened.  
**CAUTION!!** Before making final DC connection or closing DC breaker/disconnector, be sure that the positive (+) must be connected to positive (+) and negative (-) connected to negative (-).



## AC Input/Output Connection

**CAUTION!!** Before connecting to AC input power source, please install a **separate** AC breaker between the inverter and the AC input power source. This will ensure that the inverter can be safely disconnected during maintenance and fully protected from over-current. The recommended spec of AC breaker is 16A for 1.5KW and 32A for 3KW and 50A for 5KW.

**CAUTION!!** There are two power terminal blocks with "IN" (Input) and "OUT" (Output) markings. DO NOT mistakenly connect to the wrong connectors.

**WARNING!** All wiring must be performed by a qualified personnel.

**WARNING!** It's very important for system safety and efficient operation to use appropriate cable size for AC input connection. To reduce risk of injury, please use the proper recommended cable size as below.

### Suggested cable requirement for AC wires

Model	Gauge	Cable (mm <sup>2</sup> )	Torque Value
1.5KW	14 AWG	2.5	1.2 Nm
3KW	12 AWG	4	1.2 Nm
5KW	10 AWG	6	1.2 Nm

Please follow these steps to implement AC input/output connection:

1. Before making AC input/output connection, be sure to enable DC protector or disconnecter first.
2. Remove insulation sleeves for about 10mm for the five screw terminals.
3. Insert AC input wires according to polarities indicated on terminal block and tighten the terminal screws. Be sure to connect the grounding wire (⊕) first.

⊕ → **Ground (yellow-green)**

L → **LINE (brown or black)**

N → **Neutral (blue)**

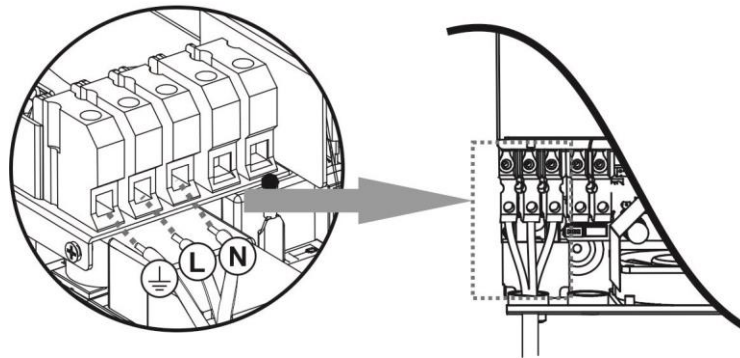

**WARNING:**

Be sure that the AC power source is disconnected before attempting wire connections.

4. Insert AC output wires according to polarities indicated on terminal block and tighten terminal screws. Be sure to connect the grounding wire (⊕) first.

⊕ → **Ground (yellow-green)**

L → **LINE (brown or black)**

N → **Neutral (blue)**

5. Make sure the wires are securely connected.

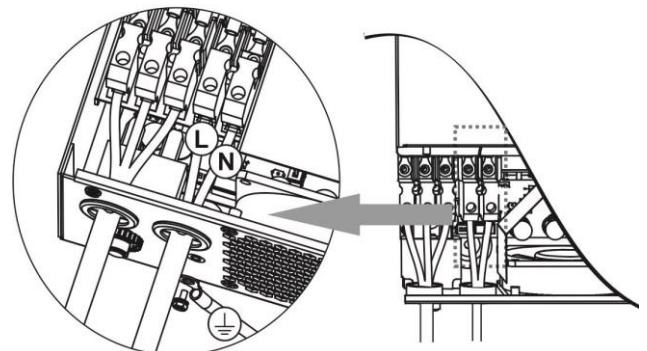

**CAUTION:** Appliances such as air conditioner required at least 2~3 minutes to spool up because it needs to have enough time to balance refrigerant gas inside of circuits. If a power shortage occurs and recovers in a short period of time, it may cause damage to your connected appliances. To prevent this from happening, please check with manufacturer of air conditioner if it has time-delay function before installation. Otherwise, this inverter will trigger overload fault and cut off output to protect your appliance but sometimes it may still causes damage to the air conditioner.

## PV Connection

**CAUTION:** Before connecting to PV modules, please install a **separately** DC circuit breaker between the inverter and PV modules.

**WARNING!** It's very important for system safety and efficient operation to use appropriate cable for PV module connection. To reduce risk of injury, please use the proper recommended cable size shown below.

Model	Wire Size	Cable (mm <sup>2</sup> )	Torque value ( max )
1.5KW	1 x 14AWG	2.5	1.2 Nm
3KW/5KW	1 x 12AWG	4	1.2 Nm

**WARNING:** Because this inverter is non-isolated, are accepted: single crystalline, poly crystalline with class A-rated and CIGS modules. To avoid any malfunctions, do not connect any PV modules with possible current leakage to the inverter. For example, grounded PV modules will cause current leakage to the inverter. When using CIGS modules, please be sure NO grounding connection.

**CAUTION:** It's requested to use PV junction box with surge protection. Otherwise, it will cause damage on inverter when lightning occurs on PV modules.

### PV Module Selection:

When selecting proper PV modules, please be sure to consider the following parameters:

1. Open circuit Voltage (Voc) of PV modules not to exceeds maximum PV array open circuit voltage of the inverter.
2. Open circuit Voltage (Voc) of PV modules should be higher than the start-up voltage.

INVERTER MODEL	1.5KW	3KW	5KW
Max. PV Array Power	2000W	4000W	5000W
Max. PV Array Open Circuit Voltage	400Vdc	500Vdc	
PV Array MPPT Voltage Range	120Vdc~380Vdc	120Vdc~450Vdc	
Start-up Voltage	150Vdc +/- 10Vdc		

Take the 250Wp PV module as an example. After considering above two parameters, the recommended module configurations are listed in the table below.

Solar Panel Spec. (reference) - 250Wp - Vmp: 30.1Vdc - Imp: 8.3A - Voc: 37.7Vdc - Isc: 8.4A - Cells: 60	SOLAR INPUT		Q'ty of panels	Total input power
	(For 1.5KW, Min in series: 5 pcs, max. in series: 8 pcs. For 3KW/5KW, Min in series: 6 pcs, max. in series: 12 pcs.)			
	6 pcs in series		6 pcs	1500W
	8 pcs in series		8 pcs	2000W
	12 pcs in series		12 pcs	3000W
	8 pieces in series and 2 sets in parallel		16 pcs	4000W
	10 pieces in series and 2 sets in parallel (only for 5KVA model)		20 pcs	5000W

### PV Module Wire Connection

Please take the following to implement PV module connection:

1. Remove insulation sleeve for about 7 mm on your positive and negative wires.
2. We recommend using bootlace ferrules on the wires for optimal performance.
3. Check polarities of wire connections from PV modules to PV input screw terminals. Connect your wires as illustrated below.  
Recommended tool: 4mm blade screwdriver

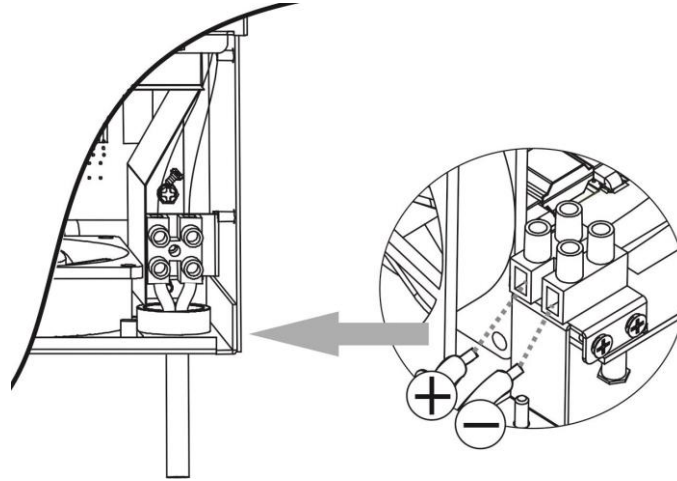
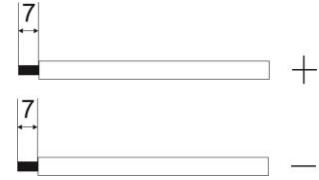

### Final Assembly

After connecting all wirings, replace the bottom cover as shown below.

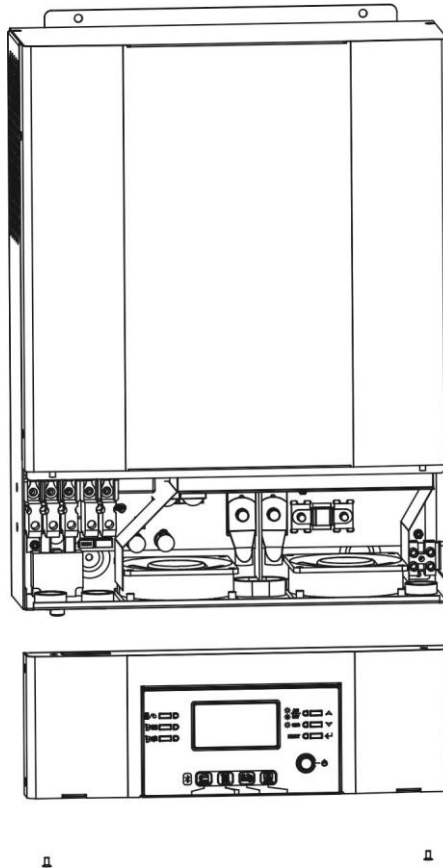

## Remote Display Panel Installation

The LCD module can be removable and installed in a remote location with an optional communication cable. Please take the follow steps to implement this remote panel installation.

**Step 1.** Remove the screw on the bottom of LCD panel and pull down the module from the case. Detach the cable from the remote communication port. Be sure to replace the retention plate back to the inverter.

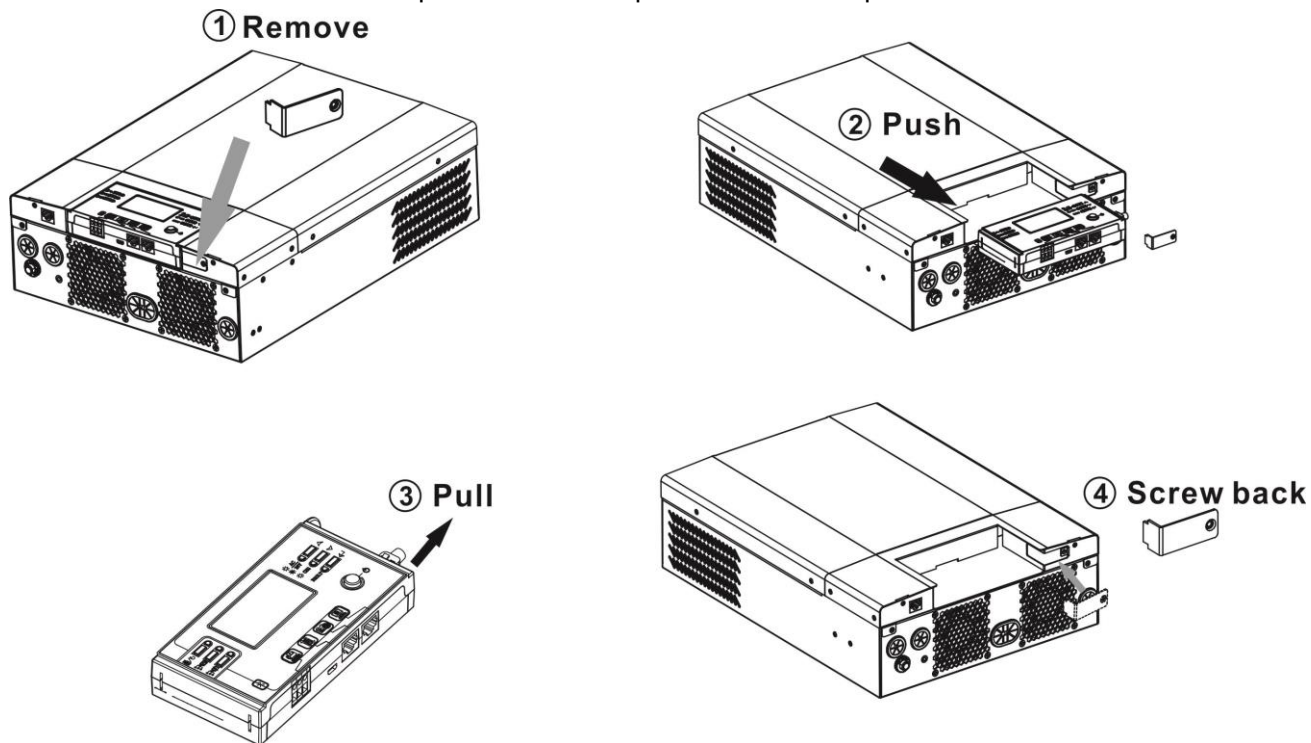

**Step 2.** Prepare your mounting holes in the marked locations as shown in the illustration below. The LCD module then can be securely mounted to your desired location.

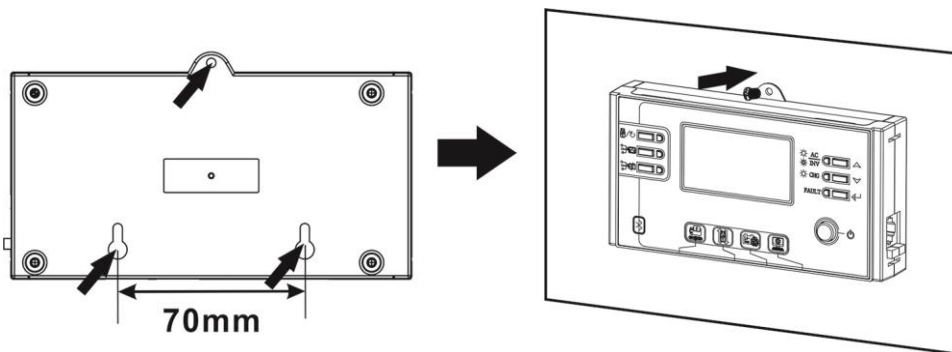

**Note:** Wall installation should be implemented with the proper screws to the right.

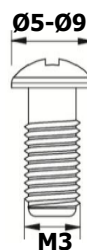

**Step 3.** Connect LCD module to the inverter with an optional RJ45 communication cable as shown below.

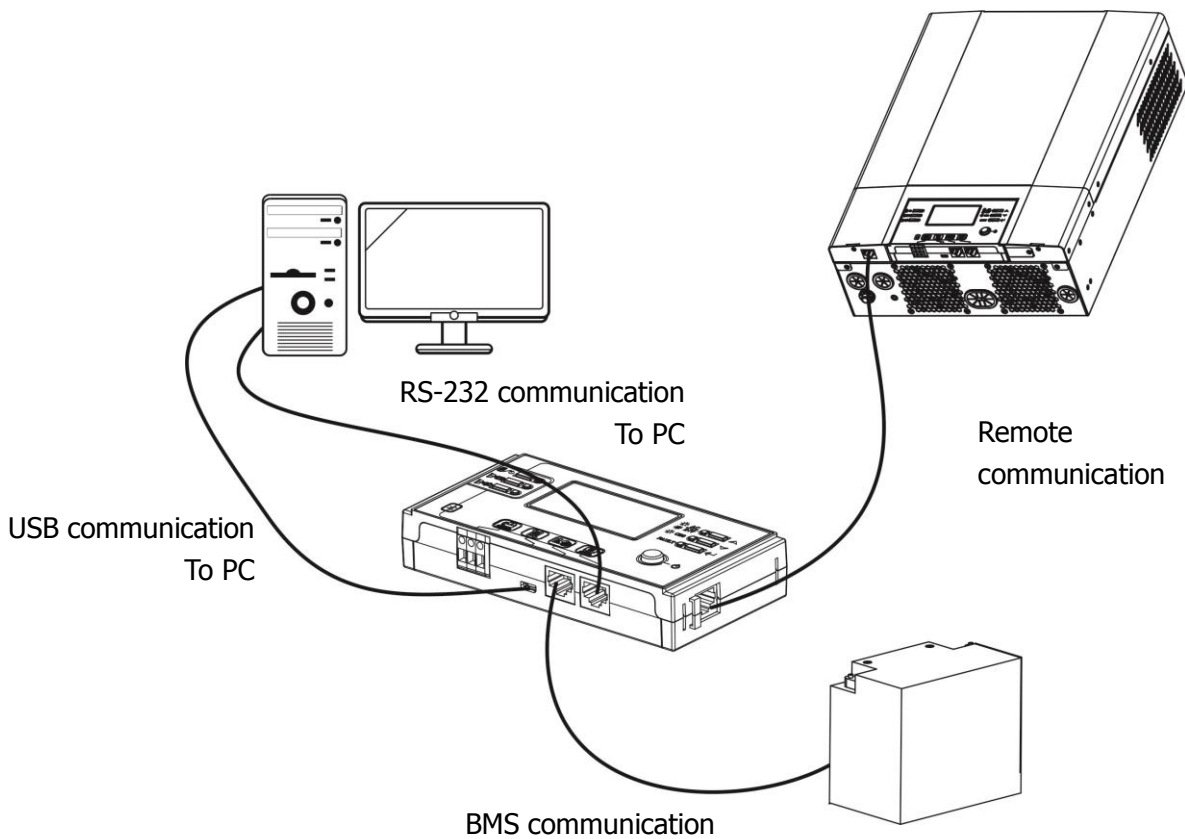

## Communication Options

### Serial Connection

Please use the supplied serial cable to connect between the inverter and your PC. Install the monitoring software from the bundled CD and follow the on-screen instructions to complete your installation. For detailed software operation, refer to the software user manual on the bundled CD.

### Bluetooth Connection

This unit is equipped with a Bluetooth transmitter. Download "WatchPower" APP from Google Play or Google Store. Once the APP is download, you may connect "WatchPower" APP to your inverter with the password "123456". The communication distance is roughly 6 ~ 7 meters.



## Dry Contact Signal

There is one dry contact (3A/250VAC) available on the rear panel. It could be used to deliver signal to external device when battery voltage reaches warning level.

Unit Status	Condition			 Dry contact port: NC C NO	
				NC & C	NO & C
Power Off	Unit is off and no output is powered.			Close	Open
Power On	Output is powered from Battery power or Solar energy.	Program 01 set as USB (utility first)	Battery voltage < Low DC warning voltage	Open	Close
			Battery voltage > Setting value in Program 13 or battery charging reaches floating stage	Close	Open
		Program 01 is set as SBU (SBU priority)	Battery voltage < Setting value in Program 12	Open	Close
			Battery voltage > Setting value in Program 13 or battery charging reaches floating stage	Close	Open

## BMS Communication

It is recommended to purchase a special communication cable if you are connecting to Lithium-Ion battery banks. Please refer to Appendix B- BMS Communication Installation for details.

# OPERATION

## Power ON/OFF

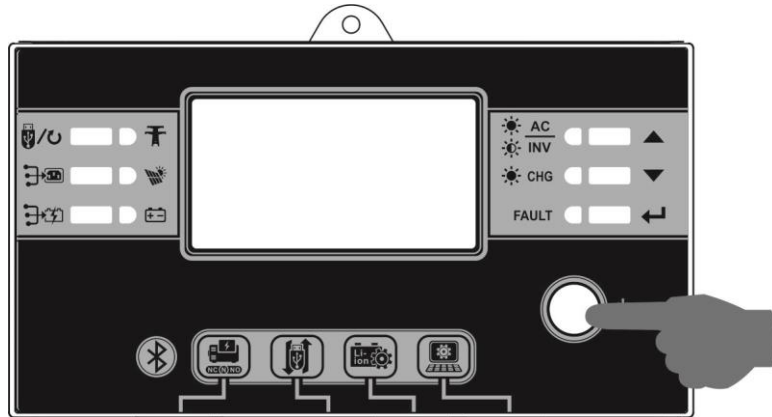

Once the unit has been properly installed and the batteries are connected well, simply press On/Off switch (located on the LCD module) to turn on the unit.

## Operation and Display Panel

The operation and the LCD module, shown in the chart below, includes six indicators, six function keys, on/off switch and a LCD display, indicating the operating status and input/output power information.

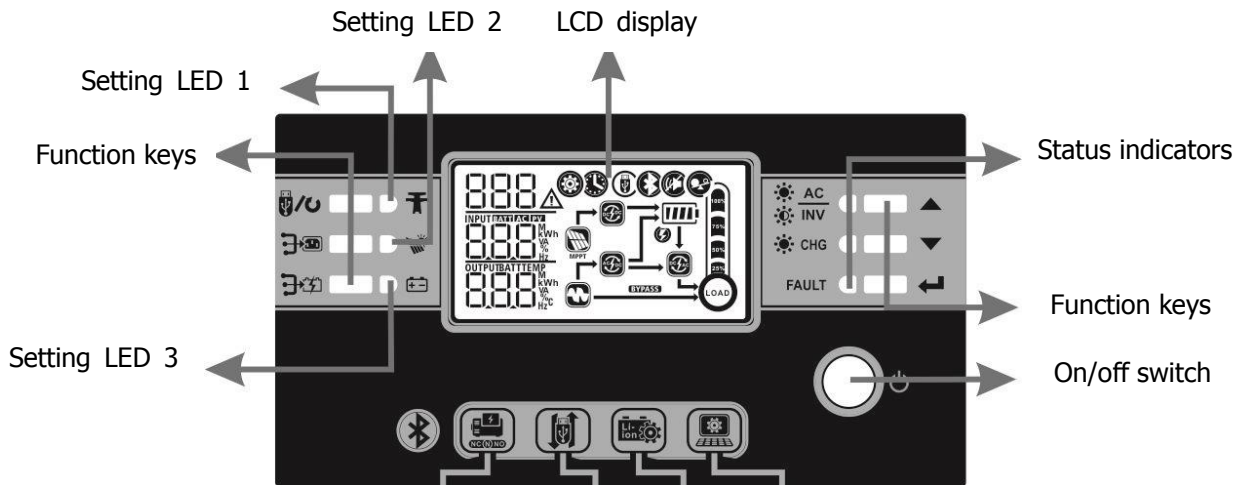

### Indicators

LED Indicator	Color	Solid/Flashing	Messages
<b>Setting LED 1</b>	Green	Solid On	Output powered by utility
<b>Setting LED 2</b>	Green	Solid On	Output powered by PV
<b>Setting LED 3</b>	Green	Solid On	Output powered by battery
<b>Status indicators</b>	 AC INV	Green Solid On	Output is available in line mode
		Green Flashing	Output is powered by battery in battery mode
	 CHG	Green Solid On	Battery is fully charged
		Green Flashing	Battery is charging.
<b>FAULT</b>	Red	Solid On	Fault mode
		Flashing	Warning mode

## Function Keys

Function Key	Description	
	ESC	Exit the setting
	USB function setting	Select USB OTG functions
	Timer setting for the Output source priority	Setup the timer for prioritizing the output source
	Timer setting for the Charger source priority	Setup the timer for prioritizing the charger source
	Up	To last selection
	Down	To next selection
	Enter	To confirm/enter the selection in setting mode

## LCD Display Icons

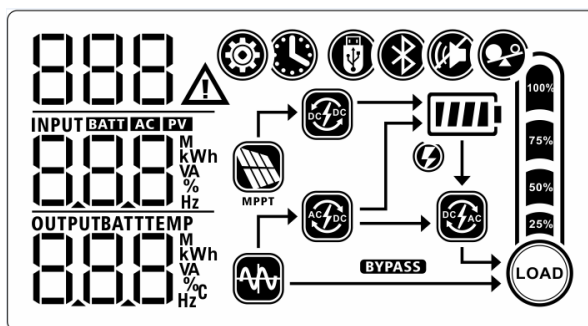

Icon	Function description	
<b>Input Source Information</b>		
	Indicates the AC input.	
	Indicates the PV input	
	Indicate input voltage, input frequency, PV voltage, charger current, charger power, battery voltage.	
<b>Configuration Program and Fault Information</b>		
	Indicates the setting programs.	
	Indicates the warning and fault codes. Warning:  flashing with warning code. Fault:  lighting with fault code	
<b>Output Information</b>		
	Indicate output voltage, output frequency, load percent, load in VA, load in Watt and discharging current.	
<b>Battery Information</b>		
	Indicates battery level by 0-24%, 25-49%, 50-74% and 75-100% in battery mode and charging status in line mode.	
In AC mode, it will present battery charging status.		
Status	Battery voltage	LCD Display
Constant	<2V/cell	4 bars will flash in turns.



Current mode / Constant Voltage mode	2 ~ 2.083V/cell	Bottom bar will be on and the other three bars will flash in turns.
	2.083 ~ 2.167V/cell	Bottom two bars will be on and the other two bars will flash in turns.
	> 2.167 V/cell	Bottom three bars will be on and the top bar will flash.
Floating mode. Batteries are fully charged.		4 bars will be on.

In battery mode, it will present battery capacity.







Load Percentage	Battery Voltage	LCD Display
Load > 50%	< 1.85V/cell	
	1.85V/cell ~ 1.933V/cell	
	1.933V/cell ~ 2.017V/cell	
	> 2.017V/cell	
Load < 50%	< 1.892V/cell	
	1.892V/cell ~ 1.975V/cell	
	1.975V/cell ~ 2.058V/cell	
	> 2.058V/cell	

### Load Information

	Indicates overload.	
	Indicates the load level by 0-24%, 25-49%, 50-74% and 75-100%.	
	0%~24%	25%~49%
	50%~74%	75%~100%

### Mode Operation Information

	Indicates unit connects to the mains.
	Indicates unit connects to the PV panel.
	Indicates load is supplied by utility power.



	Indicates the utility charger circuit is working.
	Indicates the solar charger circuit is working.
	Indicates the DC/AC inverter circuit is working.
	Indicates unit alarm is disabled.
	Indicates Bluetooth is connected.
	Indicates USB disk is connected.
	Time display page

## LCD Setting









### General Setting















After pressing and holding “←” button for 3 seconds, the unit will enter setting mode. Press “▲” or “▼” button to select setting programs. And then, press “←” button to confirm the selection or “⏏/⏪” button to exit.













### Setting Programs:

















Program	Description	Selectable option	
00	Exit setting mode	Escape 00   ESC	
01	Output source priority: To configure load power source priority	Utility first (default) 01   USB	Utility will provide power to the loads as first priority. Solar and battery energy will provide power to the loads only when utility power is not available.
		Solar first 01   SUB	Solar energy provides power to the loads as first priority. If solar energy is not sufficient to power all connected loads, battery energy will supply power the loads at the same time. Utility provides power to the loads only when any one condition happens: - Solar energy is not available - Battery voltage drops to low-level warning voltage or the setting point in program 12.













01	Output source priority: To configure load power source priority	SBU priority 01  SBU	Solar energy provides power to the loads as first priority. If solar energy is not sufficient to power all connected loads, battery energy will supply power to the loads at the same time. Utility provides power to the loads only when battery voltage drops to either low-level warning voltage or the setting point in program 12.
02	Maximum charging current: To configure total charging current for solar and utility chargers. (Max. charging current = utility charging current + solar charging current)	10A 02  10 <sup>A</sup>	20A 02  20 <sup>A</sup>
		30A 02  30 <sup>A</sup>	40A 02  40 <sup>A</sup>
		50A 02  50 <sup>A</sup>	60A (default) 02  60 <sup>A</sup>
		70A (only for 3KW/5KW) 02  70 <sup>A</sup>	80A (only for 3KW/5KW) 02  80 <sup>A</sup>
03	AC input voltage range	Appliances (default) 03  APL	If selected, acceptable AC input voltage range will be within 90-280VAC.
		UPS 03  UPS	If selected, acceptable AC input voltage range will be within 170-280VAC.

05	Battery type	AGM (default) 05 	Flooded 05 
		AGM AGM	FLD FLD
		User-Defined 05 	If "User-Defined" is selected, battery charge voltage and low DC cut-off voltage can be set up in program 26, 27 and 29.
		USE USE	
		Pylontech battery 05 	If selected, programs of 02, 26, 27 and 29 will be automatically set up. No need for further setting.
		PYL PYL	
		WECO battery (only for 48V model) 05 	If selected, programs of 02, 12, 26, 27 and 29 will be auto-configured per battery supplier recommended. No need for further adjustment.
WEC WEC			
Soltaro battery (only for 48V model) 05 	If selected, programs of 02, 26, 27 and 29 will be automatically set up. No need for further setting.		
SOL SOL			
LiB-protocol compatible battery 05 	Select " LiB" if using Lithium battery compatible to Lib protocol. If selected, programs of 02, 26, 27 and 29 will be automatically set up. No need for further setting.		
LiB LiB			
3 <sup>rd</sup> party Lithium battery 05 	If selected, programs of 02, 26, 27 and 29 will be automatically set up. No need for further setting. Please contact the battery supplier for installation procedure.		
LiC LiC			











06	Auto restart when overload occurs	Restart disable (default) 06   LFD	Restart enable 06   LFE
07	Auto restart when over temperature occurs	Restart disable (default) 07   LFD	Restart enable 07   LFE
09	Output frequency	50Hz (default) 09   50 <sub>Hz</sub>	60Hz 09   60 <sub>Hz</sub>
10	Output voltage	220V 10   220 <sub>v</sub>	230V (default) 10   230 <sub>v</sub>
		240V 10   240 <sub>v</sub>	
11	Maximum utility charging current  Note: If setting value in program 02 is smaller than that in program in 11, the inverter will apply charging current from program 02 for utility charger.	2A 11  U61 2 <sub>A</sub>	10A 11  U61 10 <sub>A</sub>
		20A 11  U61 20 <sub>A</sub>	30A (default) 11  U61 30 <sub>A</sub>
		40A 11  U61 40 <sub>A</sub>	50A (only for 3KW/5KW) 11  U61 50 <sub>A</sub>











11	<p>Maximum utility charging current</p> <p>Note: If setting value in program 02 is smaller than that in program in 11, the inverter will apply charging current from program 02 for utility charger.</p>	<p>60A (only for 3KW/5KW)</p> <p>11 </p> <p>061</p> <p>60<sup>A</sup></p>	
12	<p>Setting voltage point back to utility source when selecting "SBU" (SBU priority) or "SUB" (solar first) in program 01.</p>	Available options in 1.5KW/3KW model:	
		<p>22.0V</p> <p>12 </p> <p>BATT 220<sup>v</sup></p>	<p>22.5V</p> <p>12 </p> <p>BATT 225<sup>v</sup></p>
		<p>23.0V (default)</p> <p>12 </p> <p>BATT 230<sup>v</sup></p>	<p>23.5V</p> <p>12 </p> <p>BATT 235<sup>v</sup></p>
		<p>24.0V</p> <p>12 </p> <p>BATT 240<sup>v</sup></p>	<p>24.5V</p> <p>12 </p> <p>BATT 245<sup>v</sup></p>
		<p>25.0V</p> <p>12 </p> <p>BATT 250<sup>v</sup></p>	<p>25.5V</p> <p>12 </p> <p>BATT 255<sup>v</sup></p>
		Available options in 5KW model:	
		<p>44V</p> <p>12 </p> <p>BATT 44<sup>v</sup></p>	<p>45V</p> <p>12 </p> <p>BATT 45<sup>v</sup></p>
		<p>46V (default)</p> <p>12 </p> <p>BATT 46<sup>v</sup></p>	<p>47V</p> <p>12 </p> <p>BATT 47<sup>v</sup></p>









12	Setting voltage point back to utility source when selecting "SBU" (SBU priority) or "SUB" (solar first) in program 01.	48V 12   BATT 48 v	49V 12   BATT 49 v
		50V 12   BATT 50 v	51V 12   BATT 51 v
13	Setting voltage point back to battery mode when selecting "SBU" (SBU priority) or "SUB" (solar first) in program 01.	Available options in 1.5KW/3KW model:	
		Battery fully charged 13   BATT FUL	24V 13   BATT 240 v
		24.5V 13   BATT 245 v	25V 13   BATT 250 v
		25.5V 13   BATT 255 v	26V 13   BATT 260 v
		26.5V 13   BATT 265 v	27V (default) 13   BATT 270 v
		27.5V 13   BATT 275 v	28V 13   BATT 280 v
		28.5V 13   BATT 285 v	29V 13   BATT 290 v

















13	Setting voltage point back to battery mode when selecting "SBU" (SBU priority) or "SUB" (solar first) in program 01.	Available options in 5KW model:	
		Battery fully charged 13  BATT FUL	48V 13  BATT 48 <sub>v</sub>
		49V 13  BATT 49 <sub>v</sub>	50V 13  BATT 50 <sub>v</sub>
		51V 13  BATT 51 <sub>v</sub>	52V 13  BATT 52 <sub>v</sub>
		53V 13  BATT 53 <sub>v</sub>	54V (default) 13  BATT 54 <sub>v</sub>
		55V 13  BATT 55 <sub>v</sub>	56V 13  BATT 56 <sub>v</sub>
		57V 13  BATT 57 <sub>v</sub>	58V 13  BATT 58 <sub>v</sub>
16	Charger source priority: To configure charger source priority	If this inverter/charger is working in Line, Standby or Fault mode, charger source can be programmed as below:	
		Solar first 16  CS0	Solar energy will charge battery as first priority. Utility will charge battery only when solar energy is not available.





16	Charger source priority: To configure charger source priority	Solar and Utility (default) 16 	Solar energy and utility will charge battery at the same time.
		500	
		Only Solar 16 	Solar energy will be the only charger source no matter utility is available or not.
		050	
If this inverter/charger is working in Battery mode, only solar energy can charge battery. Solar energy will charge battery if it's available and sufficient.			
18	Alarm control	Alarm on (default) 18 	Alarm off 18 
		600	60F
19	Auto return to default display screen	Return to default display screen (default) 19 	If selected, no matter how users switch display screen, it will automatically return to default display screen (Input voltage /output voltage) after no button is pressed for 1 minute.
		ESP	
		Stay at latest screen 19 	If selected, the display screen will stay at latest screen user finally switches.
		1EP	
20	Backlight control	Backlight on (default) 20 	Backlight off 20 
		L00	L0F
22	Beeps while primary source is interrupted	Alarm on (default) 22 	Alarm off 22 
		R00	R0F

23	Overload bypass: When enabled, the unit will transfer to line mode if overload occurs in battery mode.	Bypass disable (default) 23   69d	Bypass enable 23   69E
25	Record Fault code	Record enable (default) 25   FEN	Record disable 25   FDS
26	Bulk charging voltage (C.V voltage)	1.5KW/3KW default setting: 28.2V 26  CV BATT 28.2 <sub>v</sub>	5KW default setting: 56.4V 26  CV BATT 56.4 <sub>v</sub>
If self-defined is selected in program 5, this program can be set up. Setting range is from 25.0V to 31.5V for 1.5KW/3KW model and 48.0V to 61.0V for 5KW model. Increment of each click is 0.1V.			
27	Floating charging voltage	1.5KW/3KW default setting: 27.0V 27  FLV BATT 27.0 <sub>v</sub>	5KW default setting: 54.0V 27  FLV BATT 54.0 <sub>v</sub>
If self-defined is selected in program 5, this program can be set up. Setting range is from 25.0V to 31.5V for 1.5KW/3KW model and 48.0V to 61.0V for 5KW model. Increment of each click is 0.1V.			
29	Low DC cut-off voltage	1.5KW/3KW default setting: 21.0V 29  CV BATT 21.0 <sub>v</sub>	5KW default setting: 42.0V 29  CV BATT 42.0 <sub>v</sub>
If self-defined is selected in program 5, this program can be set up. Setting range is from 21.0V to 24.0V for 1.5KW/3KW model and 42.0V to 48.0V for 5KW model. Increment of each click is 0.1V. Low DC cut-off voltage will be fixed to setting value no matter what percentage of load is connected.			

30	Battery equalization	Battery equalization 30  EEN	Battery equalization disable (default) 30  EdS
If "Flooded" or "User-Defined" is selected in program 05, this program can be set up.			
31	Battery equalization voltage	1.5KW/3KW default setting: 29.2V 31  EV BATT 29.2 <sub>v</sub>	5KW default setting: 58.4V 31  EV BATT 58.4 <sub>v</sub>
Setting range is from 25.0V to 31.5V for 1.5KW/3KW model and 48.0V to 61.0V for 5KW model. Increment of each click is 0.1V.			
33	Battery equalized time	60min (default) 33  60	Setting range is from 5min to 900min. Increment of each click is 5min.
34	Battery equalized timeout	120min (default) 34  120	Setting range is from 5min to 900 min. Increment of each click is 5 min.
35	Equalization interval	30days (default) 35  30d	Setting range is from 0 to 90 days. Increment of each click is 1 day
36	Equalization activated immediately	Enable 36  REN	Disable (default) 36  Rds
If equalization function is enabled in program 30, this program can be set up. If "Enable" is selected in this program, it's to activate battery equalization immediately and LCD main page will shows "E9". If "Disable" is selected, it will cancel equalization function until next activated equalization time arrives based on program 35 setting. At this time, "E9" will not be shown in LCD main page.			



37	Reset PV and Load energy storage	Not reset(Default) 37  nft	Reset 37  f5t
93	Erase all data log	Not reset(Default) 93  nft	Reset 93  f5t
94	Data log stored period	3 days 94  3	5 days 94  5
		10 days (default) 94  10	20 days 94  20
		30 days 94  30	60 days 94  60
95	Time setting – Minute	For minute setting, the range is from 00 to 59. 95   n10 00	
96	Time setting – Hour	For hour setting, the range is from 00 to 23. 96   H00 00	
97	Time setting– Day	For day setting, the range is from 00 to 31. 97   DAY 01	





98	Time setting– Month	For month setting, the range is from 01 to 12. 
99	Time setting – Year	For year setting, the range is from 17 to 99. 

## Function Setting















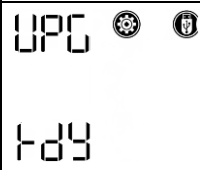

There are three function keys on the display panel to implement special functions such as USB OTG, timer setting for output source priority and timer setting for charger source priority.

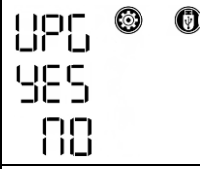
### 1. USB Function Setting

Please insert USB disk into USB port () . Press and hold "" button for 3 seconds to enter USB function setting mode. These functions include to upgrade inverter firmware, export data log and re-write internal parameters from USB disk.

Procedure	LCD Screen
<b>Step 1:</b> Press and hold "  " button for 3 seconds to enter USB function setting mode.	
<b>Step 2:</b> Press "  ", "  " or "  " button to enter the selectable setting programs.	

**Step 3:** Please select setting program by following each procedure.

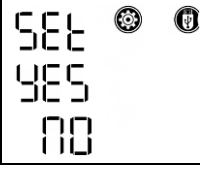
Program#	Operation Procedure	LCD Screen
 : Upgrade firmware	If pressing "  " button to proceed the firmware upgrade function. If the selected function is ready, LCD will display "  ". Please press "  " button to confirm the selection again.	
	Press "  " to select "Yes" or "  " button to select "No". Then, press "  " button to exit setting mode.	
 : Re-write internal parameters	If pressing "  " button to proceed parameters re-write from USB function. If selected function is ready, LCD will display "  ". Please press "  " button to confirm the selection again.	
	Press "  " to select "Yes" or "  " button to select "No". Then, press "  " button to exit setting mode.	

	<b>IMPORTANT NOTE:</b> After this function is executed, partial LCD setting programs will be locked. For the detailed information, please check your installer directly.	
: Export data log	If pressing "	LOG
	Press "	LOG YES NO

If no button is pressed for 1 minute, it will automatically return to main screen.

### Error message for USB On-the-Go functions:

Error Code	Messages
U01	No USB disk is detected.
U02	USB disk is protected from copy.
U03	Document inside the USB disk with wrong format.

If any error occurs, error code will only show 3 seconds. After three seconds, it will automatically return to display screen.

## 2. Timer Setting for Output Source Priority

This timer setting is to set up the output source priority per day.

Procedure	LCD Screen
<b>Step 1:</b> Press and hold "	USB
<b>Step 2:</b> Press "	SUB SUB







**Step 3:** Please select setting program by following each procedure.

Program#	Operation Procedure	LCD Screen
	If pressing "	USB 00 00
	If pressing "	SUB 00 00
	If pressing "	SUB 00 00







































Press "/U" button to exit setting mode.

### 3. Timer Setting for the Charger Source Priority

This timer setting is to set up the charger source priority per day.

Procedure	LCD Screen
<b>Step 1:</b> Press and hold "  " button for 3 seconds to enter timer setting mode for charger source priority.	 
<b>Step 2:</b> Press "  , "  " or "  " button to enter the selectable setting programs.	

**Step 3:** Please select setting program by following each procedure.

Program#	Operation Procedure	LCD Screen
	If pressing "  /U" button to set up timer. Press "  " to select start time. Press "  " or "  " button to set the start time and then press "  " button to confirm. Press "  " button to select end time. Press "  " or "  " button to set the end time and then press "  " button to confirm. The setting range is from 00 to 23. Increment of each click is 1 hour.	  
	If pressing "  " button to set up timer. Press "  " to select start time. Press "  " or "  " button to set the start time and then press "  " button to confirm. Press "  " button to select end time. Press "  " or "  " button to set the end time and then press "  " button to confirm. The setting range is from 00 to 23. Increment of each click is 1 hour.	  
	If pressing "  " button to set up timer. Press "  " to select start time setting. Press "  " or "  " button to set the start time and then press "  " button to confirm. Press "  " button to select end time. Press "  " or "  " button to set the end time and then press "  " button to confirm. The setting range is from 00 to 23. Increment of each click is 1 hour.	  

Press "/U" button to exit setting mode.

## Display Setting

The LCD display information will be switched in turns by pressing "UP" or "DOWN" key. The selectable information is switched as the following table in order.

Selectable information	LCD display
Input voltage/Output voltage (Default Display Screen)	<p>Input Voltage=230V, output voltage=230V</p>
Input frequency	<p>Input frequency=50Hz</p>
PV voltage	<p>PV voltage=260V</p>
PV current	<p>PV current = 2.5A</p>
PV power	<p>PV power = 500W</p>



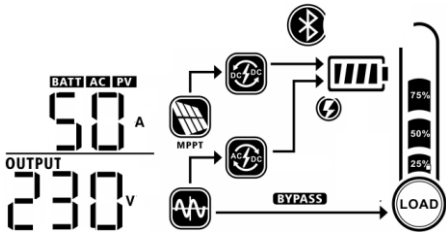
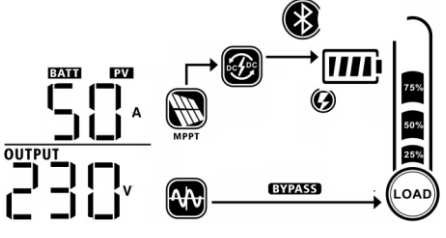
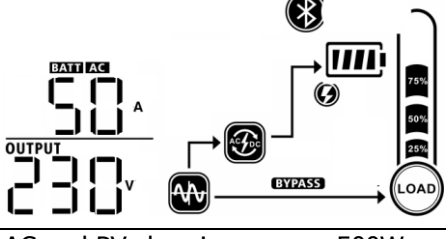
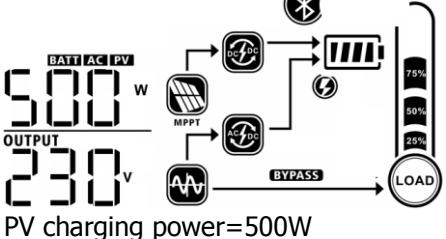
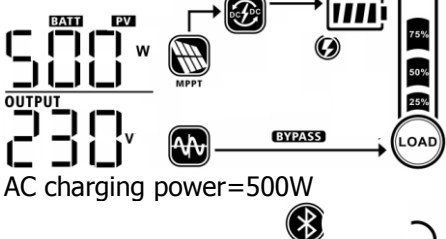
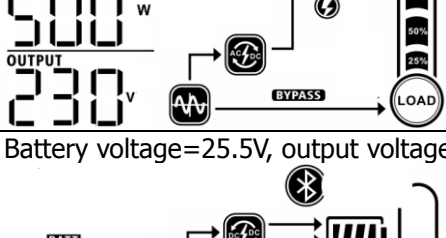
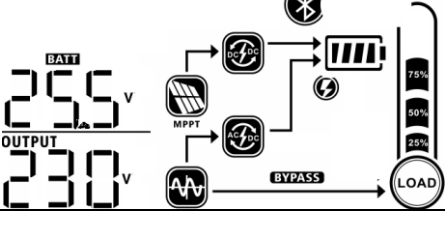

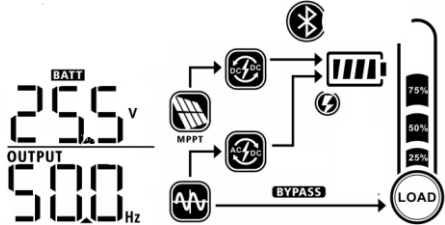
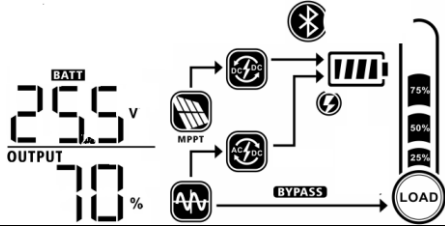
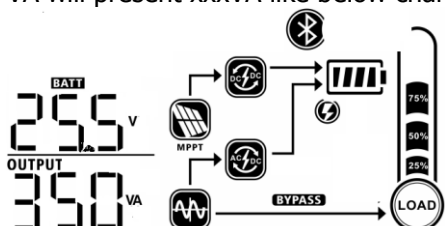
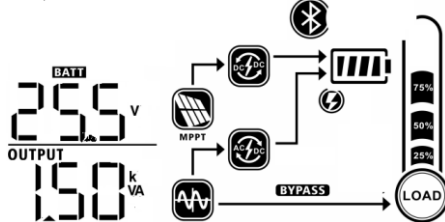
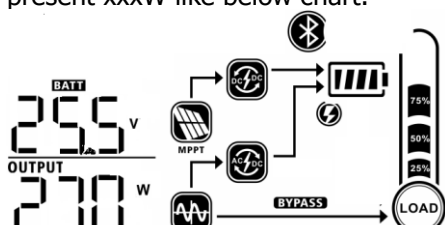
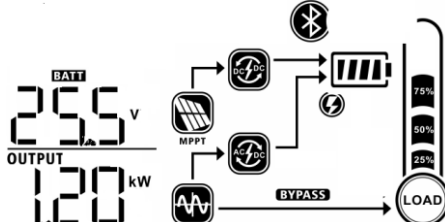
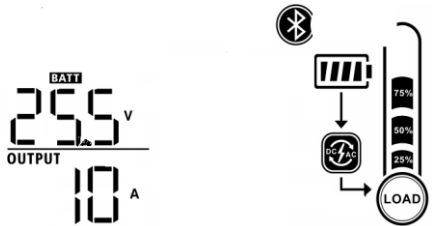

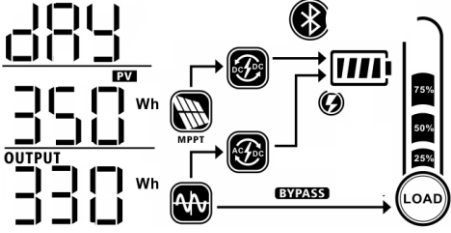
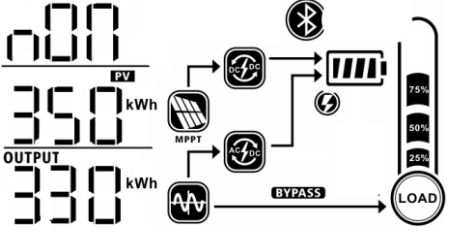
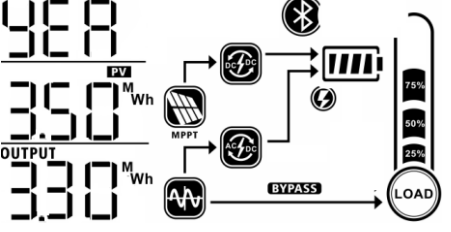
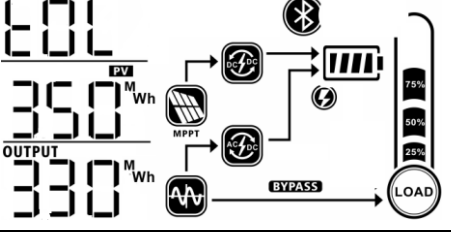
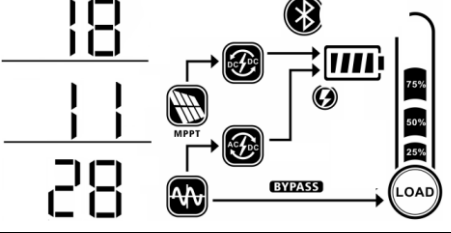
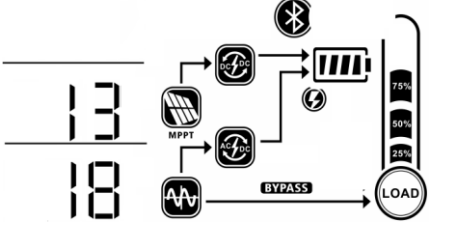
<p>Charging current</p>	<p>AC and PV charging current=50A</p>  <p>PV charging current=50A</p>  <p>AC charging current=50A</p> 
<p>Charging power</p>	<p>AC and PV charging power=500W</p>  <p>PV charging power=500W</p>  <p>AC charging power=500W</p> 
<p>Battery voltage and output voltage</p>	<p>Battery voltage=25.5V, output voltage=230V</p> 

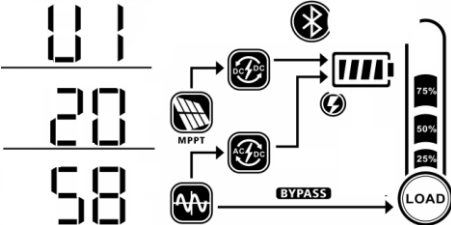
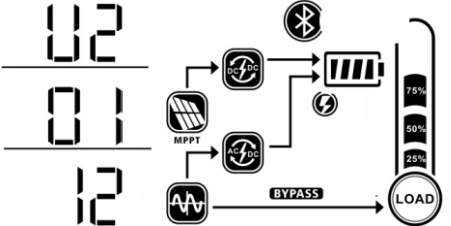
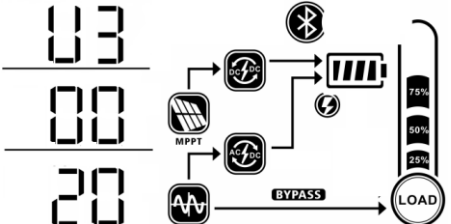
Output frequency	<p>Output frequency=50Hz</p> 
Load percentage	<p>Load percent=70%</p> 
Load in VA	<p>When connected load is lower than 1kVA, load in VA will present xxxVA like below chart.</p>  <p>When load is larger than 1kVA (<math>\geq 1\text{kVA}</math>), load in VA will present x.xkVA like below chart.</p> 
Load in Watt	<p>When load is lower than 1kW, load in W will present xxxW like below chart.</p>  <p>When load is larger than 1kW (<math>\geq 1\text{kW}</math>), load in W will present x.xkW like below chart.</p> 
Battery voltage/DC discharging current	<p>Battery voltage=25.5V, discharging current=1A</p> 

<p>PV energy generated today and Load output energy today</p>	<p>This PV Today energy = 3.88kWh, Load Today energy= 9.88kWh.</p> 
<p>PV energy generated this month and Load output energy this month.</p>	<p>This PV month energy = 388kWh, Load month energy= 988kWh.</p> 
<p>PV energy generated this year and Load output energy this year.</p>	<p>This PV year energy = 3.88MWh, Load year energy = 9.88MWh.</p> 
<p>PV energy generated totally and Load output total energy.</p>	<p>PV Total energy = 350MWh, Load Output Total energy = 330MWh.</p> 
<p>Real date.</p>	<p>Real date Nov 28, 2018.</p> 
<p>Real time.</p>	<p>Real time 13:18.</p> 

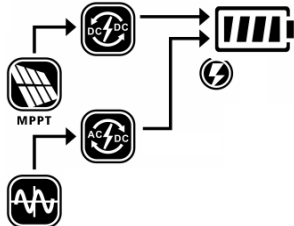
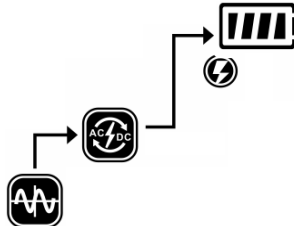
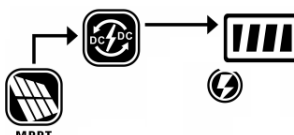
<p>Main CPU version checking.</p>	<p>Main CPU version 00020.58.</p>  <p>The display shows the version number 00020.58 in a digital font. To the right is a schematic diagram of the power system. It includes a solar panel icon, an MPPT (Maximum Power Point Tracking) controller, two DC-DC converters, a battery pack, a Bluetooth symbol, a lightning bolt symbol, and a LOAD. A BYPASS switch is shown between the solar panel and the battery pack.</p>
<p>Secondary CPU version checking.</p>	<p>Secondary CPU version 00001.12.</p>  <p>The display shows the version number 00001.12 in a digital font. To the right is a schematic diagram of the power system, identical to the one in the first row.</p>
<p>Secondary Bluetooth version checking.</p>	<p>Secondary Bluetooth version 00000.20.</p>  <p>The display shows the version number 00000.20 in a digital font. To the right is a schematic diagram of the power system, identical to the ones in the previous rows.</p>

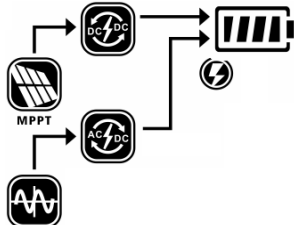
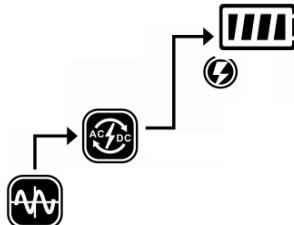
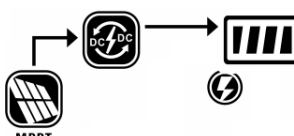
# Operating Mode Description

Operation mode	Description	LCD display
<p>Standby mode</p> <p><b>Note:</b></p> <p>*Standby mode: The inverter is not turned on yet but at this time, the inverter can charge battery without AC output.</p>	<p>No output is supplied by the unit but it still can charge batteries.</p>	<p>Charging by utility and PV energy.</p> 
		<p>Charging by utility.</p> 
		<p>Charging by PV energy.</p> 
		<p>No charging.</p> 
<p>Fault mode</p> <p>Note:</p> <p>*Fault mode: Errors are caused by inside circuit error or external reasons such as over temperature, output short circuited and so on.</p>	<p>PV energy and utility can charge batteries.</p>	<p>Charging by utility and PV energy.</p> 
		<p>Charging by utility.</p> 
		<p>Charging by PV energy.</p> 
		<p>No charging.</p> 

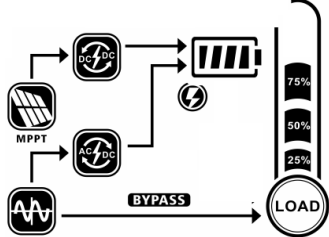
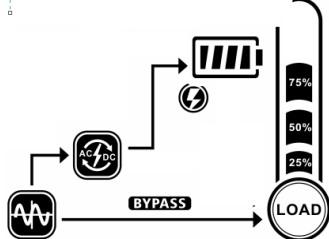
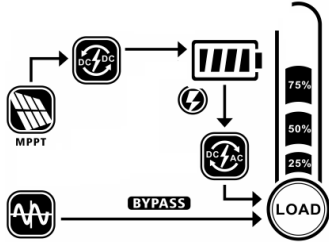
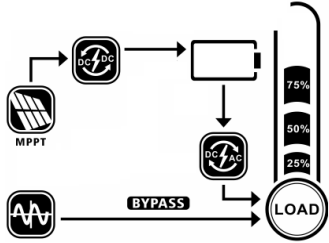
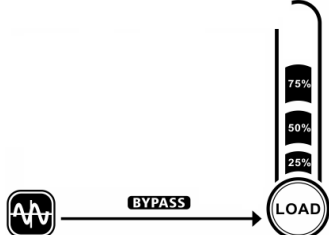
Operation mode	Description	LCD display
Line Mode	The unit will provide output power from the mains. It will also charge the battery at line mode.	<p>Charging by utility and PV energy.</p> 
		<p>Charging by utility.</p> 
		<p>If "SUB" (solar first) is selected as output source priority and solar energy is not sufficient to provide the load, solar energy and the utility will provide the loads and charge the battery at the same time.</p> 
		<p>If "SUB" (solar first) is selected as output source priority and battery is not connected, solar energy and the utility will provide the loads.</p> 
		<p>Power from utility.</p> 

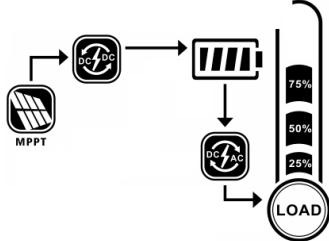
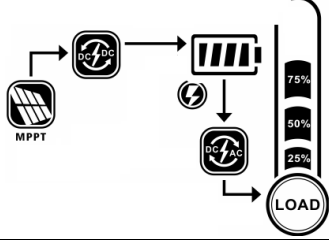
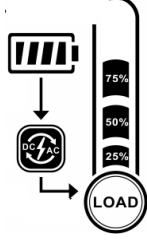
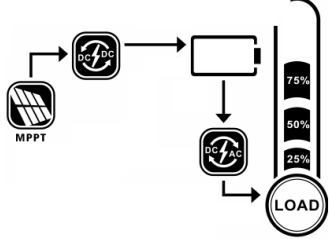
Operation mode	Description	LCD display
Battery Mode	The unit will provide output power from battery and/or PV power.	Power from battery and PV energy. 
		PV energy will supply power to the loads and charge battery at the same time. No utility is available. 
		Power from battery only. 
		Power from PV energy only. 

## Battery Equalization Description

Battery equalization function is built into the charge controller. It reverses the buildup of negative chemical effects such as stratification, a condition where acid concentration is greater at the bottom of the battery than at the top. Equalization also helps to remove sulfate crystals that may have built up on the plates. If left unchecked, this condition, called sulfation, will reduce the overall capacity of the battery. Therefore, it's recommended to equalize the battery periodically.

- **How to Activate Equalization Function**

You must enable battery equalization function in LCD setting Program 30 first. You can then apply this function by either one of the following methods:

1. Setting equalization interval in Program 35.
2. Activate equalization immediately in Program 36.

- **When to Equalize**

In floating charge stage, when setting the equalization interval (battery equalization cycle) is reached, or equalization is activated immediately, the controller will start to enter Equalize Mode.

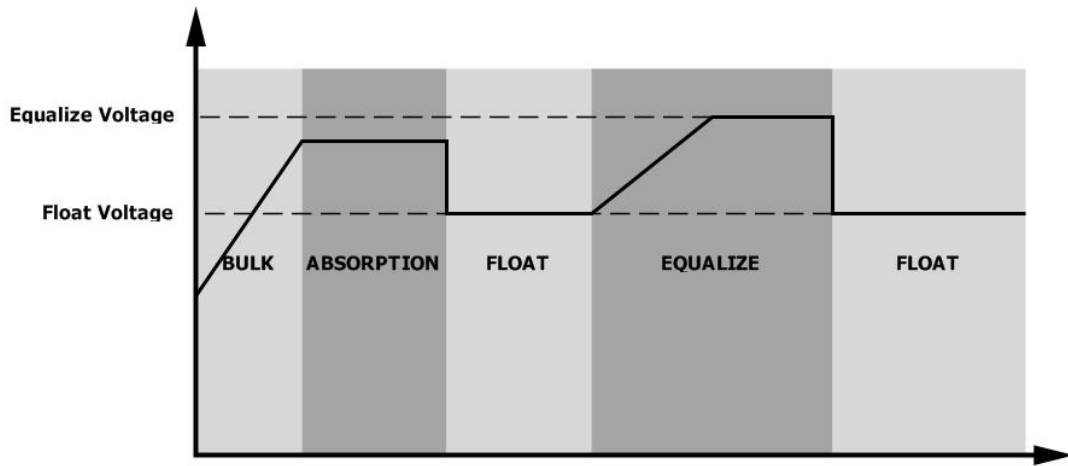

- **Equalize Charging and Timeout**

In Equalize Mode, the controller will supply power to charge battery as much as possible until battery voltage reach the equalization voltage. Then, constant-voltage regulation is applied to maintain battery voltage at the equalization level. The battery will remain in the Equalize Mode until the equalization timer runs out.

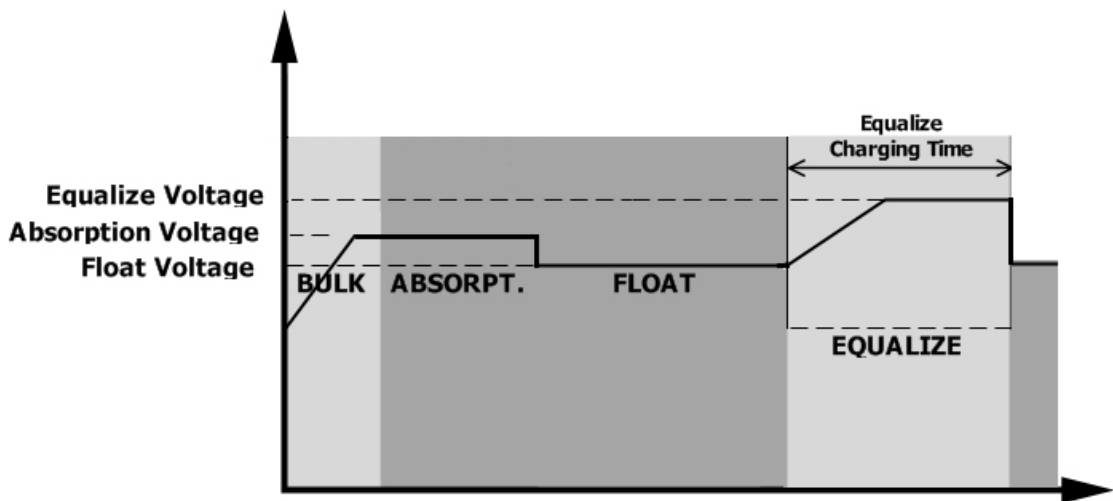

However, in Equalize Mode, if the battery equalization timer runs out and the battery voltage doesn't recover to the battery equalization voltage point, the charge controller will extend the battery equalized time until battery voltage achieves equalization voltage. If the battery voltage is still lower than equalization voltage when the extension runs out, the charge controller will stop equalization and return to the floating charging stage.

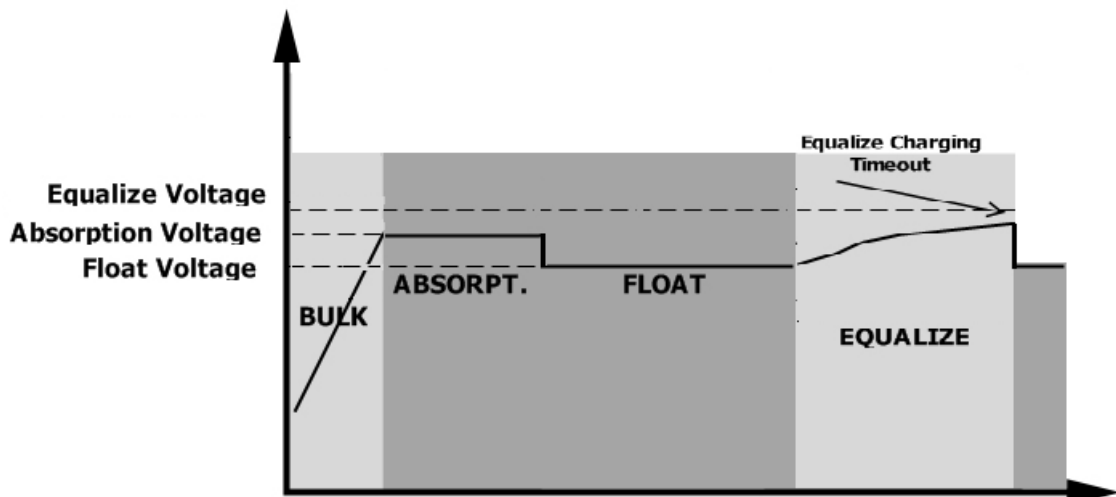















## Fault Reference Code

Fault Code	Fault Event	Icon on
01	Fan is locked when inverter is off.	F01
02	Over temperature	F02
03	Battery voltage is too high	F03
04	Battery voltage is too low	F04
05	Output short circuited or over temperature is detected by internal converter components.	F05
06	Output voltage is too high.	F06
07	Overload time out	F07
08	Bus voltage is too high	F08
09	Bus soft start failed	F09
51	Over current or surge	F51
52	Bus voltage is too low	F52
53	Inverter soft start failed	F53
55	Over DC voltage in AC output	F55
57	Current sensor failed	F57
58	Output voltage is too low	F58
59	PV voltage is over limitation	F59

## Warning Indicator

Warning Code	Warning Event	Audible Alarm	Icon flashing
01	Fan is locked when inverter is on.	Beep three times every second	01 
02	Over temperature	None	02 
03	Battery is over-charged	Beep once every second	03 
04	Low battery	Beep once every second	04 
07	Overload	Beep once every 0.5 second	07  
10	Output power derating	Beep twice every 3 seconds	10 
15	PV energy is low.	Beep twice every 3 seconds	15 
16	High AC input (>280VAC) during BUS soft start	None	16 
32	Communication interrupted	None	32 
E9	Battery equalization	None	E9 
6P	Battery is not connected	None	6P  

# SPECIFICATIONS

Table 1 Line Mode Specifications

INVERTER MODEL	1.5KW	3KW	5KW
<b>Input Voltage Waveform</b>	Sinusoidal (utility or generator)		
<b>Nominal Input Voltage</b>	230Vac		
<b>Low Loss Voltage</b>	170Vac±7V (UPS); 90Vac±7V (Appliances)		
<b>Low Loss Return Voltage</b>	180Vac±7V (UPS); 100Vac±7V (Appliances)		
<b>High Loss Voltage</b>	280Vac±7V		
<b>High Loss Return Voltage</b>	270Vac±7V		
<b>Max AC Input Voltage</b>	300Vac		
<b>Nominal Input Frequency</b>	50Hz / 60Hz (Auto detection)		
<b>Low Loss Frequency</b>	40±1Hz		
<b>Low Loss Return Frequency</b>	42±1Hz		
<b>High Loss Frequency</b>	65±1Hz		
<b>High Loss Return Frequency</b>	63±1Hz		
<b>Output Short Circuit Protection</b>	Circuit Breaker		
<b>Efficiency (Line Mode)</b>	>95% ( Rated R load, battery full charged )		
<b>Transfer Time</b>	10ms typical (UPS); 20ms typical (Appliances)		
<p><b>Output power derating:</b> When AC input voltage drops to 170V, the output power will be derated.</p>	<p>The graph illustrates the output power derating characteristics. The vertical axis represents Output Power, with specific levels for 50% Power and Rated Power. The horizontal axis represents Input Voltage, with key points at 90V, 170V, and 280V. The power remains constant at a low level until 90V, then increases linearly to reach the Rated Power at 170V. It remains constant at the Rated Power level until 280V, after which it drops to zero.</p>		

Table 2 Inverter Mode Specifications

<b>INVERTER MODEL</b>	<b>1.5KW</b>	<b>3KW</b>	<b>5KW</b>
<b>Rated Output Power</b>	1.5KVA/1.5KW	3KVA/3KW	5KVA/5KW
<b>Output Voltage Waveform</b>	Pure Sine Wave		
<b>Output Voltage Regulation</b>	230Vac±5%		
<b>Output Frequency</b>	50Hz		
<b>Peak Efficiency</b>	93%		
<b>Overload Protection</b>	5s@≥130% load; 10s@105%~130% load		
<b>Surge Capacity</b>	2* rated power for 5 seconds		
<b>Nominal DC Input Voltage</b>	24Vdc		48Vdc
<b>Cold Start Voltage</b>	23.0Vdc		46.0Vdc
<b>Low DC Warning Voltage</b> @ load < 50% @ load ≥ 50%	23.0Vdc 22.0Vdc		46.0Vdc 44.0Vdc
<b>Low DC Warning Return Voltage</b> @ load < 50% @ load ≥ 50%	23.5Vdc 23.0Vdc		47.0Vdc 46.0Vdc
<b>Low DC Cut-off Voltage</b> @ load < 50% @ load ≥ 50%	21.5Vdc 21.0Vdc		43.0Vdc 42.0Vdc
<b>High DC Recovery Voltage</b>	32Vdc		62Vdc
<b>High DC Cut-off Voltage</b>	33Vdc		63Vdc
<b>No Load Power Consumption</b>	<35W		<50W

Table 3 Charge Mode Specifications

Utility Charging Mode			
INVERTER MODEL	1.5KW	3KW	5KW
Charging Algorithm	3-Step		
AC Charging Current (Max)	40Amp (@V <sub>I/P</sub> =230Vac)	100Amp (@V <sub>I/P</sub> =230Vac)	
Bulk Charging Voltage	Flooded Battery	29.2	
	AGM / Gel Battery	28.2	
Floating Charging Voltage	27Vdc		54Vdc
Charging Curve			
MPPT Solar Charging Mode			
INVERTER MODEL	1.5KW	3KW	5KW
Max. PV Array Power	2000W	4000W	5000W
Nominal PV Voltage	240Vdc		320Vdc
Start-up Voltage	150Vdc +/- 10Vdc		
PV Array MPPT Voltage Range	120~380Vdc	120~450Vdc	
Max. PV Array Open Circuit Voltage	400Vdc	500Vdc	
Max Charging Current (AC charger plus solar charger)	60A	100Amp	

Table 4 General Specifications

INVERTER MODEL	1.5KW	3KW	5KW
Operating Temperature Range	-10°C to 50°C		
Storage temperature	-15°C~ 60°C		
Humidity	5% to 95% Relative Humidity (Non-condensing)		
Dimension (D*W*H), mm	100 x 280 x 390	115 x 300 x 400	
Net Weight, kg	8.5	9	10

## TROUBLE SHOOTING

Problem	LCD/LED/Buzzer	Explanation / Possible cause	What to do
Unit shuts down automatically during startup process.	LCD/LEDs and buzzer will be active for 3 seconds and then complete off.	The battery voltage is too low (<1.91V/Cell)	1. Re-charge battery. 2. Replace battery.
No response after power on.	No indication.	1. The battery voltage is far too low. (<1.4V/Cell) 2. Internal fuse tripped.	1. Contact repair center for replacing the fuse. 2. Re-charge battery. 3. Replace battery.
Mains exist but the unit works in battery mode.	Input voltage is displayed as 0 on the LCD and green LED is flashing.	Input protector is tripped	Check if AC breaker is tripped and AC wiring is connected well.
	Green LED is flashing.	Insufficient quality of AC power. (Shore or Generator)	1. Check if AC wires are too thin and/or too long. 2. Check if generator (if applied) is working well or if input voltage range setting is correct. (UPS→Appliance)
	Green LED is flashing.	Set "SUB" (solar first) as the priority of output source.	Change output source priority to "USB" (utility first).
When the unit is turned on, internal relay is switched on and off repeatedly.	LCD display and LEDs are flashing	Battery is disconnected.	Check if battery wires are connected well.
Buzzer beeps continuously and red LED is on.	Fault code 07	Overload error. The inverter is overload 110% and time is up.	Reduce the connected load by switching off some equipment.
		If PV input voltage is higher than specification, the output power will be derated. At this time, if connected loads is higher than derated output power, it will cause overload.	Reduce the number of PV modules in series or the connected load.
	Fault code 05	Output short circuited.	Check if wiring is connected well and remove abnormal load.
		Temperature of internal converter component is over 120°C.	Check whether the air flow of the unit is blocked or whether the ambient temperature is too high.
	Fault code 02	Internal temperature of inverter component is over 100°C.	Return to repair center.
	Fault code 03	Battery is over-charged.	Return to repair center.
		The battery voltage is too high.	Check if spec and quantity of batteries are meet requirements.
	Fault code 01	Fan fault	Replace the fan.
	Fault code 06/58	Output abnormal (Inverter voltage below than 190Vac or is higher than 260Vac)	1. Reduce the connected load. 2. Return to repair center
	Fault code 08/09/53/57	Internal components failed.	Return to repair center.
	Fault code 51	Over current or surge.	Restart the unit, if the error happens again, please return to repair center.
	Fault code 52	Bus voltage is too low.	
Fault code 55	Output voltage is unbalanced.		
Fault code 59	PV input voltage is beyond the specification.	Reduce the number of PV modules in series.	

## Appendix A: Approximate Back-up Time Table

Model	Load (VA)	Backup Time @ 24Vdc 100Ah (min)	Backup Time @ 24Vdc 200Ah (min)
1.5KW	150	908	2224
	300	449	1100
	450	338	815
	600	222	525
	750	177	414
	900	124	303
	1050	110	269
	1200	95	227
	1350	82	198
	1500	68	164

Model	Load (VA)	Backup Time @ 24Vdc 100Ah (min)	Backup Time @ 24Vdc 200Ah (min)
3KW	300	449	1100
	600	222	525
	900	124	303
	1200	95	227
	1500	68	164
	1800	56	126
	2100	48	108
	2400	35	94
	2700	31	74
	3000	28	67

Model	Load (VA)	Backup Time @ 48Vdc 100Ah (min)	Backup Time @ 48Vdc 200Ah (min)
5KW	500	613	1288
	1000	268	613
	1500	158	402
	2000	111	271
	2500	90	215
	3000	76	182
	3500	65	141
	4000	50	112
	4500	44	100
	5000	40	90

**Note:** Backup time depends on the quality of the battery, age of battery and type of battery. Specifications of batteries may vary depending on different manufacturers.

# Appendix B: BMS Communication Installation

## 1. Introduction

If connecting to lithium battery, it is recommended to purchase a custom-made RJ45 communication cable. Please check with your dealer or integrator for details.

This custom-made RJ45 communication cable delivers information and signal between lithium battery and the inverter. These information are listed below:

- Re-configure charging voltage, charging current and battery discharge cut-off voltage according to the lithium battery parameters.
- Have the inverter start or stop charging according to the status of lithium battery.

## 2. Lithium Battery Communication Configuration

### PYLONTECH

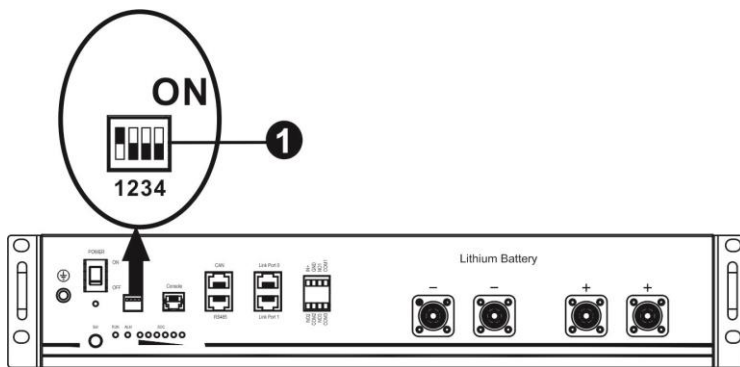

① Dip Switch: There are 4 Dip Switches that sets different baud rate and battery group address. If switch position is turned to the "OFF" position, it means "0". If switch position is turned to the "ON" position, it means "1".

Dip 1 is "ON" to represent the baud rate 9600.

Dip 2, 3 and 4 are reserved for battery group address.

Dip switch 2, 3 and 4 on master battery (first battery) are to set up or change the group address.

**NOTE:** "1" is upper position and "0" is bottom position.

Dip 1	Dip 2	Dip 3	Dip 4	Group address
1: RS485 baud rate=9600  <b>Restart to take effect</b>	0	0	0	Single group only. It's required to set up master battery with this setting and slave batteries are unrestricted.
	1	0	0	Multiple group condition. It's required to set up master battery on the first group with this setting and slave batteries are unrestricted.
	0	1	0	Multiple group condition. It's required to set up master battery on the second group with this setting and slave batteries are unrestricted.
	1	1	0	Multiple group condition. It's required to set up master battery on the third group with this setting and slave batteries are unrestricted.
	0	0	1	Multiple group condition. It's required to set up master battery on the fourth group with this setting and slave batteries are unrestricted.
	1	0	1	Multiple group condition. It's required to set up master battery on the fifth group with this setting and slave batteries are unrestricted.

**NOTE:** The maximum groups of lithium battery is 5 and for maximum number for each group, please check with battery manufacturer.

### 3. Installation and Operation

After configuration, please install LCD panel with inverter and Lithium battery with the following steps.

Step 1. Use custom-made RJ45 cable to connect inverter and Lithium battery.

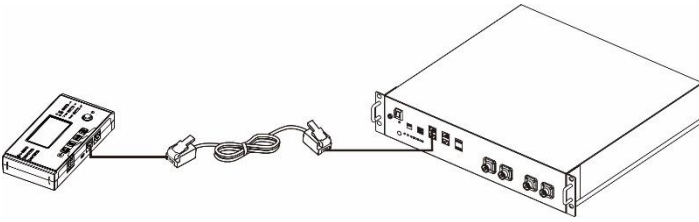

Step 2. Switch on Lithium battery.

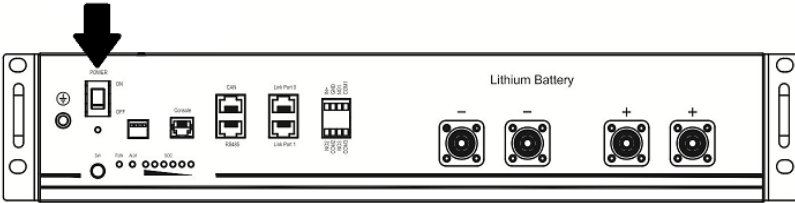

Step 3. Press more than three seconds to start Lithium battery. Output power is ready.

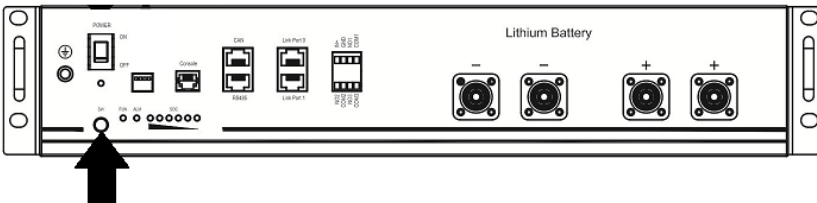

Step 4. Turn on the inverter.

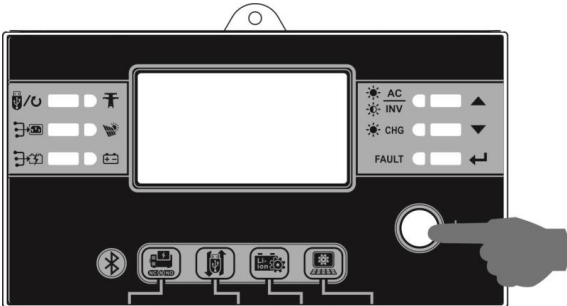

Step 5. Be sure to select battery type as "PYL" in LCD program 5.

05 

PYL

If communication between the inverter and battery is successful, the battery icon  on LCD display will flash. Generally speaking, it will take longer than 1 minute to establish communication.

#### Active Function

This function is to activate lithium battery automatically while commissioning. After battery wiring and commissioning is successfully, if battery is not detected, the inverter will automatically activate battery if the inverter is powered on.



## WECO

Step 1. Use a custom-made RJ45 cable to connect inverter and Lithium battery.

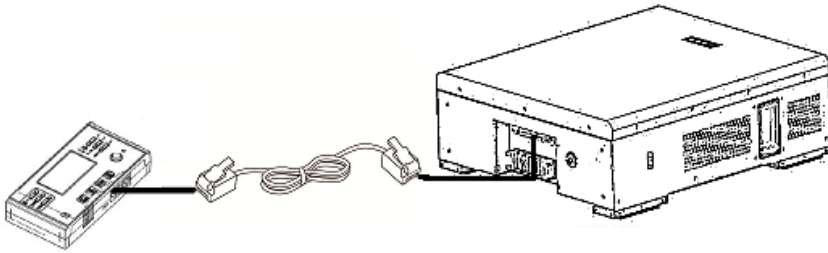

Step 2. Switch on Lithium battery.

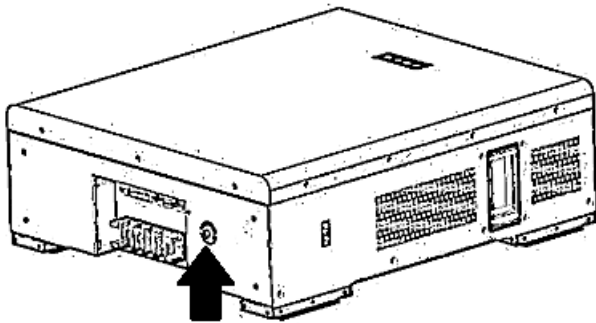

Step 3. Turn on the inverter.

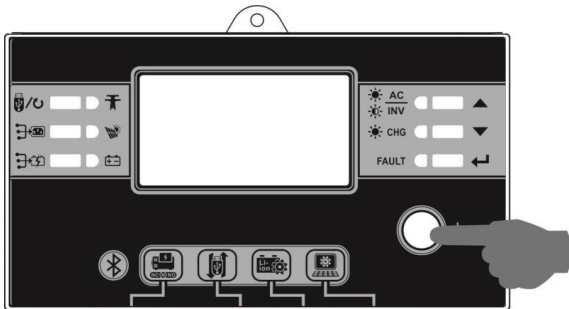

Step 4. Be sure to select battery type as "WEC" in LCD program 5.

05 

WEC

If communication between the inverter and battery is successful, the battery icon  on LCD display will "flash". Generally speaking, it will take longer than 1 minute to establish communication.

## SOLTARO

Step 1. Use a custom-made RJ45 cable to connect inverter and Lithium battery.

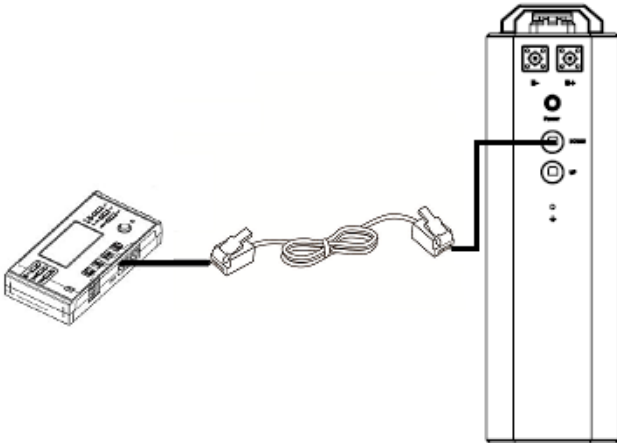

Step 2. Open DC isolator and switch on Lithium battery.

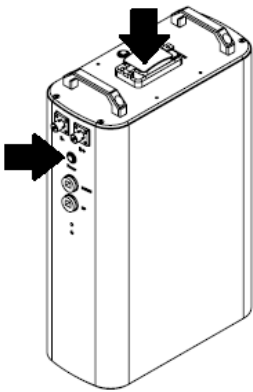

Step 3. Turn on the inverter.

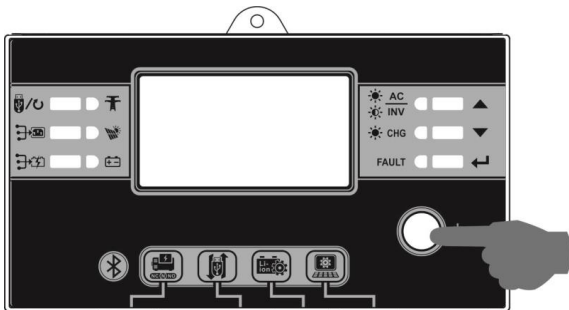

Step 4. Be sure to select battery type as "SOL" in LCD program 5.

05 

SOL

If communication between the inverter and battery is successful, the battery icon  on LCD display will "flash". Generally speaking, it will take longer than 1 minute to establish communication.

#### 4. LCD Display Information

Press "UP" or "DOWN" key to switch LCD display information. It will show battery pack and battery group number before "Main CPU version checking" as below screen.

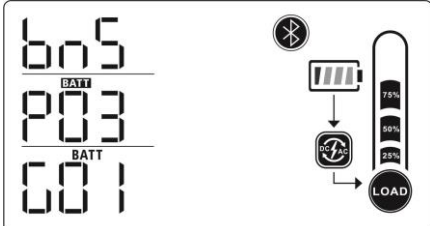
Selectable information	LCD display
Battery pack numbers & Battery group numbers	Battery pack numbers = 3, battery group numbers = 1 

#### 5. Code Reference

Related information code will be displayed on LCD screen. Please check inverter LCD screen for the operation.

Code	Description	Action
60 ⚠	If battery status is not allowed to charge and discharge after the communication between the inverter and battery is successful, it will show code 60 to stop charging and discharging battery.	
61 ⚠	Communication lost (only available when the battery type is setting as "Pylontech Battery".) <ul style="list-style-type: none"> <li>After battery is connected, communication signal is not detected for 3 minutes, buzzer will beep. After 10 minutes, inverter will stop charging and discharging to lithium battery.</li> <li>Communication lost occurs after the inverter and battery is connected successfully, buzzer beeps immediately.</li> </ul>	
69 ⚠	If battery status is not allowed to charge after the communication between the inverter and battery is successful, it will show code 69 to stop charging battery.	
70 ⚠	If battery status must to be charged after the communication between the inverter and battery is successful, it will show code 70 to charge battery.	
71 ⚠	If battery status is not allowed to discharge after the communication between the inverter and battery is successful, it will show code 71 to stop discharging battery.	